

Memorex®

Is it live or is it Memorex?™

MPD8600

User's Guide

*Personal FM
Stereo Compact
Disc MP3 Player*

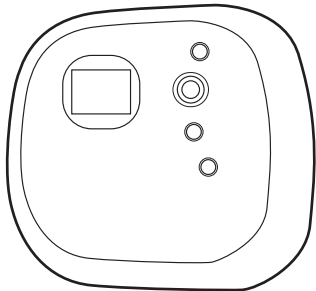

**Before operating this product,
please read these instructions completely.**

SAFETY PRECAUTIONS



CAUTION

**RISK OF ELECTRIC SHOCK
DO NOT OPEN**



CAUTION: TO REDUCE THE RISK OF ELECTRIC SHOCK, DO NOT REMOVE COVER (OR BACK). NO USER-SERVICEABLE PARTS INSIDE. REFER SERVICING TO QUALIFIED SERVICE PERSONNEL.



DANGEROUS VOLTAGE:

The lightning flash with arrowhead symbol within an equilateral triangle is intended to alert the user to the presence of uninsulated dangerous voltage within the product's enclosure that may be of sufficient magnitude to constitute a risk of electric shock to persons.



ATTENTION:

The exclamation point within an equilateral triangle is intended to alert the user to the presence of important operating and maintenance (servicing) instructions in the literature accompanying the appliance.

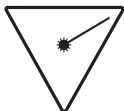

DANGER:

This product utilizes a Class 1 laser to read compact discs. This laser Compact Disc Player is equipped with safety switches to avoid exposure when the CD door is open and the safety interlocks are defeated. Invisible and hazardous laser radiation when open and interlock failed or defeated. Avoid direct exposure to beam. Please do not attempt to defeat or bypass the safety switches.

SAFETY PRECAUTIONS (CONTINUED)

FCC WARNING:

This equipment may generate or use radio frequency energy. Changes or modifications to this equipment may cause harmful interference unless the modifications are expressly approved in the instruction manual. The user could lose the authority to operate this equipment if an unauthorized change or modification is made.

INFORMATION:

This equipment has been tested and found to comply with the limits for a Class B digital device, pursuant to Part 15 of the FCC Rules. These limits are designed to provide reasonable protection against harmful interference in a residential installation. This equipment generates, uses and can radiate radio frequency energy and, if not installed and used in accordance with the instructions, may cause harmful interference to radio communications. However, there is no guarantee that interference will not occur in a particular installation. If this equipment does cause harmful interference to radio or television reception, which can be determined by turning the equipment off and on, the user is encouraged to try to correct the interference by one or more of the following measures:

- Reorient or relocate the receiving antenna.
- Increase the separation between the equipment and receiver.
- Connect the equipment into an outlet on a circuit different from that to which the receiver is connected.
- Consult the dealer or an experienced radio/TV technician for help.

SAFETY PRECAUTIONS (CONTINUED)

SURGE PROTECTORS:

It is recommended to use a surge protector for AC connection. Lightning and power surges ARE NOT covered under warranty for this product.

- Do not open the CD compartment while the CD is rotating.
- Always keep the CD compartment closed when not in use.
- Keep all foreign objects out of the CD compartment.
- Place the unit on a stable surface.
- Avoid installing the unit in locations described below:
 - Places exposed to direct sunlight or close to heat-radiating appliances such as electric heaters.
 - On top of other stereo equipment that radiate too much heat.
 - Places lacking ventilation or dusty places.
 - Places subject to constant vibration.
 - Humid or moist places.

Dear Customer:

Selecting fine audio equipment such as the unit you've just purchased is only the start of your musical enjoyment. Now it's time to consider how you can maximize the fun and excitement your equipment offers. This manufacturer and the Electronic Industries Association's Consumer Electronics Group want you to get the most out of your equipment by playing it at a safe level. One that lets the sound come through loud and clear without annoying blaring or distortion and, most importantly, without affecting your sensitive hearing.

Sound can be deceiving. Over time your hearing "comfort level" adapts to higher volumes of sound. So what sounds "normal" can actually be loud and harmful to your hearing. Guard against this by setting your equipment at a safe level BEFORE your hearing adapts.

To establish a safe level:

- Start your volume control at a low setting.
- Slowly increase the sound until you can hear it comfortably and clearly, and without distortion.

Once you have established a comfortable sound level:

- Set the dial and leave it there.

Taking a minute to do this now will help to prevent hearing damage or loss in the future. After all, we want you listening for a lifetime.

We Want You Listening For A Lifetime

Used wisely, your new sound equipment will provide a lifetime of fun and enjoyment. Since hearing damage from loud noise is often undetectable until it is too late, this manufacturer and the Electronic Industries Association's Consumer Electronics Group recommend you avoid prolonged exposure to excessive noise. This list of sound levels is included for your protection.

Decibel

Level

Example

30	Quiet library, soft whispers
40	Living room, refrigerator, bedroom away from traffic
50	Light traffic, normal conversation, quiet office
60	Air conditioner at 20 feet, sewing machine
70	Vacuum cleaner, hair dryer, noisy restaurant
80	Average city traffic, garbage disposals, alarm clock at two feet

THE FOLLOWING NOISES CAN BE DANGEROUS UNDER CONSTANT EXPOSURE:

90	Subway, motorcycle, truck traffic, lawn mower
100	Garbage truck, chain saw, pneumatic drill
120	Rock band concert in front of speakers, thunderclap
140	Gunshot blast, jet engine
180	Rocket launching pad

Information courtesy of the Deafness Research Foundation.



LOCATION OF CONTROLS

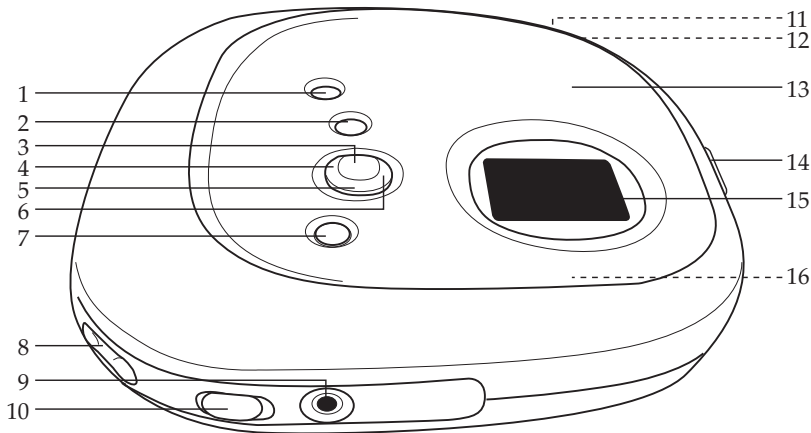

1. PROG (Program) Button
2. EQ/NAVI (Navigation) Button
3. Stop (■)/Power Off Button
4. Skip/Search/Tuning Up (▶▶) Button
5. Play/Pause (▶||)/Power On Button
6. Skip/Search/Tuning Down (◀◀) Button
7. MODE/Radio On Button
8. VOLUME/Radio Preset -/+ Buttons
9. Headphones Jack

10. Hold Switch
11. DC 4.5V Jack (Side of Unit)

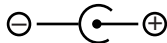

12. LINE OUT Jack (Side of Unit)
13. CD Compartment
14. CD Door OPEN Switch
15. Display
16. Battery Compartment (Under CD Compartment Door)

INSTALLATION

This CD player requires either two (2) “AA” cell standard batteries (not included) or the AC adapter (not included).

BATTERY INSTALLATION

The low battery indicator () will light in the display when batteries are low (when using battery power) and need replacing.

1. Open the battery compartment door under the CD compartment Door by pushing the latch in and then lifting it. **To prevent the possibility of losing the cover, it cannot be removed.**
2. Insert two (2) “AA” cell batteries (not included) according to the polarity diagram inside the battery compartment. Alkaline batteries are recommended for the longest playing time.

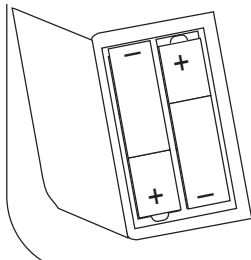

BATTERY PRECAUTIONS

Follow these precautions when using batteries in this device:

1. Use only the size and type of batteries specified.
2. Be sure to follow the correct polarity when installing the batteries as indicated next to the battery compartment. Reversed batteries may cause damage to the device.
3. Do not mix different types of batteries together (e.g. Alkaline, Rechargeable and Carbon-zinc) or old batteries with fresh ones.
4. If the device is not to be used for a long period of time, remove the batteries to prevent damage or injury from possible battery leakage.
5. Do not try to recharge batteries not intended to be recharged; they can overheat and rupture. (Follow battery manufacturer's directions.)

INSTALLATION (CONTINUED)

AC OPERATION

To operate the unit using AC power, connect an AC adapter (not included) to an AC outlet having 120V, 60Hz AC only. Plug the small end into the DC 4.5V jack on the side of the unit and connect the other end into the AC outlet. The batteries are automatically disconnected when the AC adapter is used.

CAUTION: When not using AC power, disconnect the AC adapter from the wall outlet by pulling the plug (not the cord). Do not touch the AC adapter with wet hands. Fully insert the plug without exposing any part of the blade.

DC 4.5V 

Sound Through a Home Audio System

By using a home audio connection cable (not included), superb sound can be heard through your home audio system. Before making any connections, turn off the power to all equipment.

Plug a connection cable (not included) between the LINE OUT jack on the side of the CD player and the amplifier's AUX or CD input jack. (Do not connect it to the amplifier's PHONO jack.)

NOTE: If the radio interferes with TV reception, move the unit away from the TV or turn off the power to this unit.

HOLD SWITCH

Slide the HOLD switch until "HOLD" appears in the display and no buttons can be pressed. After three seconds, "HOLD" will disappear in the display. If you press any button, "HOLD" will appear in the display again to indicate the button is disabled. This is useful when jogging/walking. Slide the HOLD switch to the off position to cancel the Hold function.

OPERATION

TO LISTEN TO THE RADIO

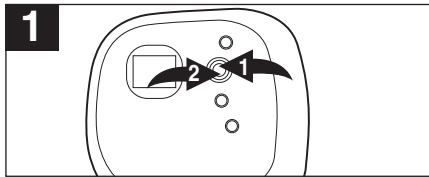

1 Plug the headphones into the Headphones jack. Press the Play/Pause (▶||)/Power On button ❶ to turn the unit on. If a CD is in the CD compartment, press the Stop (■)/Power Off button ❷ once to stop playback, otherwise continue to step 2.

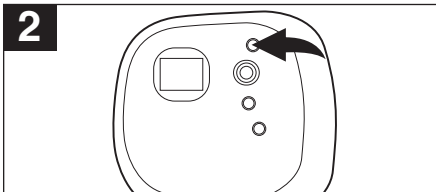

2 Press the MODE/Radio On button to enter the FM Radio mode. Press the MODE button repeatedly to select STEREO or MONO. If FM reception is weak/noisy, select Mono, in this case the reception will be monaural.

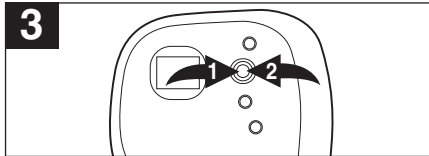

3 Press and release the Skip/Search/Tuning ◀◀ ❶ or ▶▶ ❷ button to tune a station; "Manual" will appear in the display. For rapid search tuning, press and hold the Skip/Search/Tuning ◀◀ ❶ or ▶▶ ❷ button for one second, then release; "Auto Seek" will appear in the display.

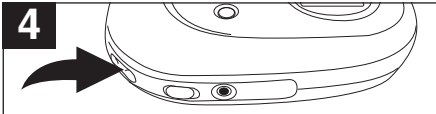

4 To adjust the volume, press and hold the VOLUME/Radio Preset -/+ buttons for one second; "VOLUME" will appear in the display. Within three seconds, press the VOLUME/Radio Preset -/+ buttons to adjust the volume. If you do not press the VOLUME/Presets -/+ for one second first, "PRESET" will appear in the display. If you then press the VOLUME/Radio Preset -/+ buttons, the Memory Preset will increase or decrease, not the volume.

CONTINUED ON THE NEXT PAGE

OPERATION (CONTINUED)

5

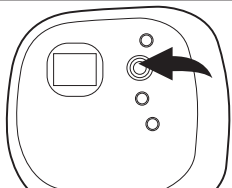

To change back to the CD mode, press the Play/Pause (▶||)/Power On button.

6

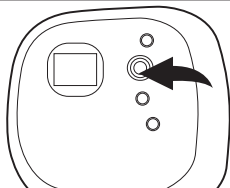

To turn the radio off, press the Stop (■)/Power Off button.

ANTENNAS

FM – The headphones act as an antenna for FM. Extend the headphone wire for best FM reception.

AUTO SCAN

Press and hold the Skip/Search/Tuning ◀◀ or ▶▶ button for approximately 1 second and the unit will automatically search for the next available station.

OPERATION (CONTINUED)

TO SET AND RECEIVE A STATION INTO MEMORY

1

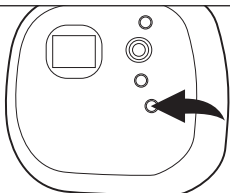

Tune a desired station as described in the previous section. Press the PROG button; the memory number will blink and PROG indicator will appear.

2

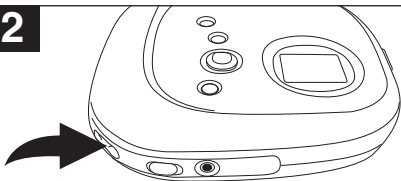

Within five seconds, repeatedly press and release the VOLUME/Radio Preset +/- buttons to select a Memory Preset (up to 30 memories).

3

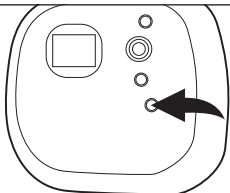

Press the PROG button again to confirm.

4

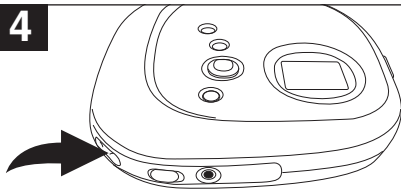

To receive a Memory Preset, press the VOLUME/Radio Preset +/- buttons until the desired preset appears in the display.

OPERATION (CONTINUED)

TO INSERT AND PLAY A CD

This CD player is designed to play all kinds of Audio Discs, WMA and MP3 CD ROMS, such as CD recordables and rewritables. Do not try to play CDI, CDV, DVD or computer CDs in this unit.

1

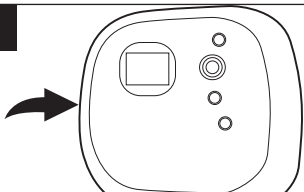

Open the CD compartment lid by sliding the CD Door OPEN switch. Gently press a disc, label side up, onto the spindle until it locks in place. Close the CD compartment lid.

2

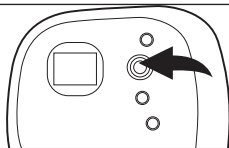

Press the Play/Pause (▶||)/Power On button to turn the unit on; the total tracks (and folders, if using MP3) will appear in the display. Then, the unit will automatically start playing the CD; the current track and elapsed playing time (CD information and folder will also appear, if using MP3) will appear in the display.

3

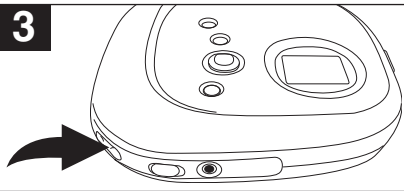

Adjust the volume as desired using the VOLUME/Radio Preset +/- buttons.

4

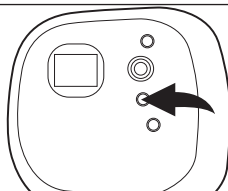

Adjust the EQ/NAVI button to cycle through the EQ settings: FLAT, CLASSIC, JAZZ, ROCK and POP.

CONTINUED ON THE NEXT PAGE

OPERATION (CONTINUED)

5

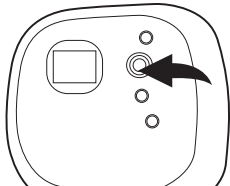

When the disc is through playing, it will stop. Press the Stop (■)/Power Off button to stop the disc before it is finished. Press the Stop (■)/Power Off button again to turn the unit off.

CD PLAYBACK NOTES:

- See page 20 for more information on MP3's.
- When recording (“burning”) CDs, make sure the session is “finalized”, or simply record (“burn”) only one session. You can find more information in your recorder’s manual.
- This unit is capable of playing standard CDs or 3” singles; no adapter is required.
- If a disc is inserted incorrectly, dirty, damaged or not present at all, “no disc” will appear in the display.
- If a disc is not recorded properly, a disc error will occur.
- Playback will stop when you open the CD compartment, but it is not recommended to open the compartment before the Stop (■)/Power Off button is pressed.
- If there is no activity for 60 seconds, the unit will turn itself off to save the batteries.
- It may take 10 to 30 seconds for the player to read an MP3 CD and begin playback, depending on the number of tracks burned on the CD.
- The EQ function is only available for CD playback.

OPERATION (CONTINUED)

TO PAUSE A CD

1

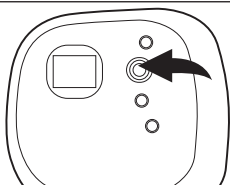

During CD playback, if you wish to pause the disc momentarily, press the Play/Pause (▶||)/Power On button. Playback will stop but the disc continues to spin and “PAUSE” will appear and the elapsed time will flash in the display.

2

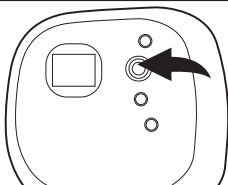

Press the Play/Pause (▶||)/Power On button again to release pause and resume playback. The sound returns and the elapsed time in the display stops flashing.

FORWARD/REVERSE SKIP TRACK

1

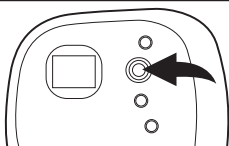

During playback, press and release the Skip/Search ▶▶ button once to advance the player to the beginning of the next track. Press the Skip/Search ▶▶ button repeatedly to advance the player to higher number tracks.

2

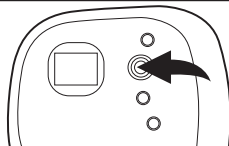

During playback, press and release the Skip/Search ◀◀ button once to move the player back to the beginning of the currently playing track. Press the Skip/Search ◀◀ button repeatedly to move the player back to lower numbered tracks.

OPERATION (CONTINUED)

HIGH-SPEED MUSIC SEARCH

1

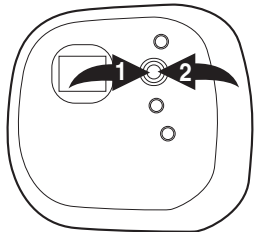

During playback, depress and hold either the Skip/Search **◀◀ 1** or **▶▶ 2** button to move the player forward or backward within a track to locate a specific musical passage. The player will move forward or backward at high speed as long as the buttons are depressed. When you release the Skip/Search **◀◀ 1** or **▶▶ 2** button, normal playback will resume.

REPEAT PLAYBACK OF ONE TRACK

1

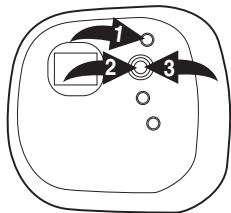

To repeat a single track, press the MODE button **1** once while playing a CD; "CD 1" will appear in the display. Press the Skip/Search **◀◀ 2** or **▶▶ 3** button to select the specific track that you wish to repeat.

2

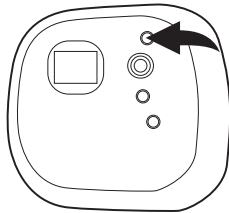

The specific track you selected will be repeated continuously. To cancel Repeat playback, press the MODE button until the Mode indicator disappears.

OPERATION (CONTINUED)

REPEAT PLAYBACK OF ALL TRACKS

1

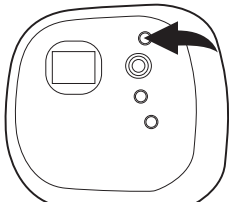

To repeat all the tracks on the CD, press the MODE button twice (three times if playing an MP3) while playing a CD; “<ALL>” will appear in the display.

2

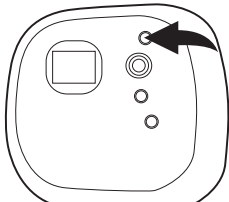

All tracks on the disc will be repeated continuously. To cancel Repeat playback, press the MODE button until the Mode indicator disappears.

REPEAT PLAYBACK OF A FOLDER/ALBUM (MP3 w/folders only)

1

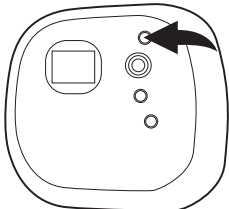

To repeat all files in a folder/album (MP3 CD only), press the MODE button twice while playing a CD; “<ALBUM>” will appear in the display.

2

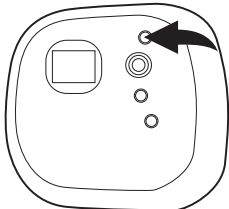

All files in the selected folder/album will be repeated continuously. To cancel Repeat playback, press the MODE button until the Mode indicator disappears. See page 20 for more info on MP3 format.

OPERATION (CONTINUED)

INTRO PLAYBACK (Will play the first 10 seconds of each track)

1

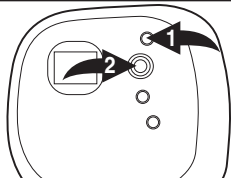

Press the MODE button ❶ three times (four times if playing an MP3) while playing a CD; "INTRO" will blink in the display. Press the Skip/Search ❷ button; "INTRO" will light solid in the display.

2

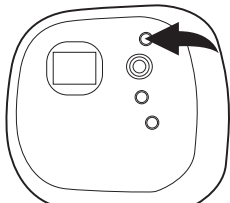

The first 10 seconds of all tracks on the disc will be played in sequence. To cancel Intro playback, press the MODE button until the Mode indicator disappears.

TO RANDOMLY PLAY BACK A CD

1

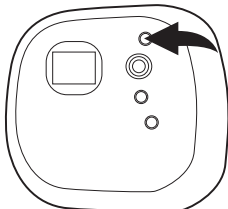

To randomly playback the tracks on CD, press the MODE button four times (five times if playing an MP3) while playing a CD; "RAND" will blink in the display.

2

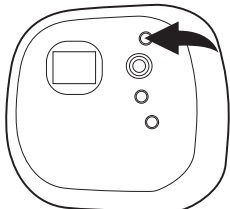

The unit will play all the tracks in random order. When all the tracks have been played, the unit will stop. To cancel Random playback, press the MODE button until the Mode indicator disappears.

OPERATION (CONTINUED)

TO PROGRAM THE MEMORY (UP TO 64 TRACKS)

Programming is the ability to preselect the order in which a series of tracks will be played.

1

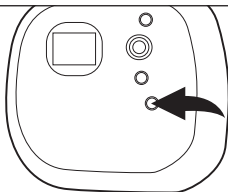

2

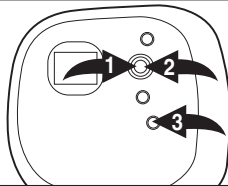

While in the Stop mode, press the PROG button. The track number will blink and "P-01" will appear in the display. (If using an MP3, the folder number will blink.)

If using an MP3/WMA, select the desired folder using the Skip/Search **⏪ ①** or **⏩ ②** button. Press the PROG button **③** to confirm.

3

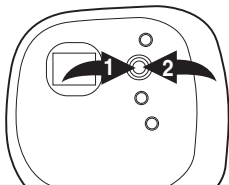

4

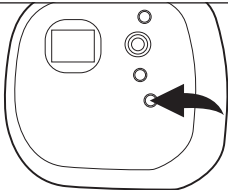

Select a track to be programmed using the Skip/Search **⏪ ①** or **⏩ ②** button.

Press the PROG button to memorize the track.

CONTINUED ON THE NEXT PAGE

OPERATION (CONTINUED)

5

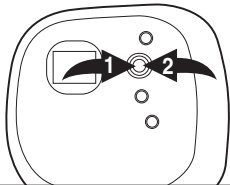

Repeat steps 2 through 4 to program additional tracks up to a maximum of 64 tracks.

6

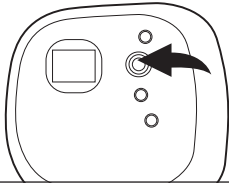

Press the Play/Pause (▶||)/Power On button to begin program playback; "PROG" will appear in the display.

NOTES ON PROGRAM PLAYBACK

- Press the Stop (■)/Power Off button while in the Program mode or change the CD to clear the memory.
- The program memory will be saved, even if the power is turned off or if the CD door is opened without changing the CD.
- You can review the program by pressing the PROG button repeatedly while in the Stop mode.
- To add a track to the program memory, simply press the PROG button, and the display will show the next available memory number, then continue as per the steps on the previous page.
- Press the Stop (■)/Power Off button to stop the program before it is finished (the program memory will be kept).
- Each file may be stored in the program memory as many times as desired (up to 64 files).
- You can scroll through the program while it is playing using the Skip/Search ◀◀ or ▶▶ button.

RESUME

This unit has Auto resume, which will resume playback of the last track listened to as well as the volume level last selected when the unit is turned on (and the same CD is still in the CD compartment). To cancel Auto Resume, you need to change the CD.

MP3 FAQs - Frequently Asked Questions

Please read before playing an MP3 CD.

Does the unit support packet write CD-RW?

Yes it can. You can add or delete MP3/WMA files without reformatting. It appears like a PC hard drive.

Can the unit read regular music CDs?

Yes, it can.

Does the unit have Electronic Skip Protection built-in?

Yes, it has an anti-shock buffer (45 seconds for standard CD and 120 seconds for MP3 CD). What that means for the everyday user is that it can withstand road bumps, shaking, etc. There will be no skipping when you jog, run on a treadmill or drive on a bumpy road.

OPERATION (CONTINUED)

Can I use the MP3 extension for non-audio data files?

No, this may result in serious malfunction and harmful noise interference.

Does the unit support multi-session CDRs?

If the MP3/WMA CD is not finalized, you can burn a new group of MP3 files until the CD is full.

Does the unit support subdirectories (subfolders)?

Yes, the unit can read music files from subfolders.

What appears on the display when playing back MP3 CDs?

The album, title and artist (if set when MP3/WMA was recorded).

OPERATION (CONTINUED)

SELECTING SONGS BY MP3/WMA TITLE

You can search for a song by title as follows:

1

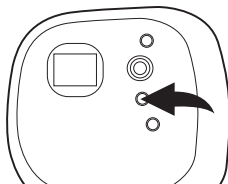

During MP3 or WMA playback, press and hold the EQ/NAVI button for more than two seconds; the File Search display will appear.

2

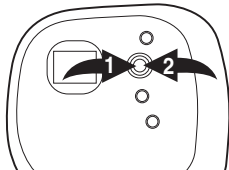

If the first letter of the title starts with a letter above F, a number or a symbol, press and hold the Skip/Search **◀▶** **1** or **▶▶** **2** button until the desired letter range appears in the display.

3

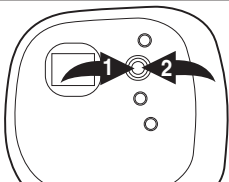

Select the first letter by pressing and releasing the Skip/Search **◀▶** **1** or **▶▶** **2** button.

4

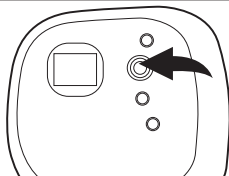

When the desired first letter appears, press the Play/Pause (**▶||**)/Power On button to select it. If there is a file that starts with that letter, the name will appear in the display. If not, "NO FILE" will appear in the display.

CONTINUED ON THE NEXT PAGE

OPERATION (CONTINUED)

5

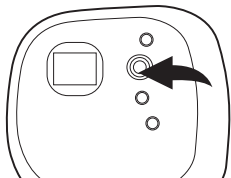

If you make a mistake, simply press the Stop (■)/Power Off button to delete the last letter entered.

6

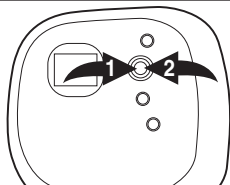

Repeat steps 2 through 4 until the desired title appears in the display, or go to step 7.

7

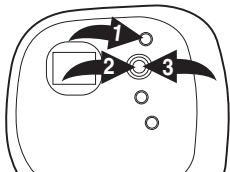

Press the MODE button ❶ to move the cursor to the title.

If desired, press the Skip/Search ◀❷❸ or ▶❹❺ button to cycle through the titles that start with the selected letter.

8

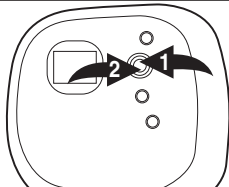

When the title appears, press the Play/Pause (▶❶❷)/Power On button ❶ to start playback or press the Stop (■)/Power Off button ❷ to exit the File Search screen.

OPERATION (CONTINUED)

SEARCHING THROUGH MP3/WMA FOLDERS

You can search the contents of the folders (if burned on CD) as follows:

1

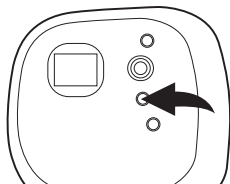

2

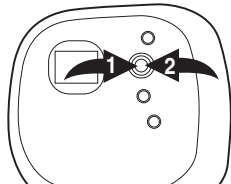

During MP3 or WMA playback, press and hold the EQ/NAVI button for more than two seconds; the File Search display will appear. Then, press the EQ/NAVI button again.

Press the Skip/Search **◀◀ 1** or **▶▶ 2** button to cycle through the folders. The first letter of the selected folder will blink and the next folder will appear below it.

3

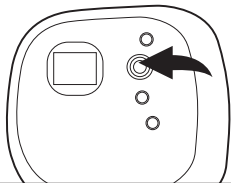

When the folder appears, press the Play/Pause (**▶||**)/Power On button to start playback of the tracks in the selected folder.

OPERATION (CONTINUED)

SINGLE SESSION

The following chart is an example of a **Windows Explorer** display that will appear on your computer monitor for a single session MP3/WMA CD ROM with directories/albums. Check the added notes to help you understand the MP3/WMA CD unit display and the playback sequence of directories/ albums and tracks on a single session MP3/WMA CD.

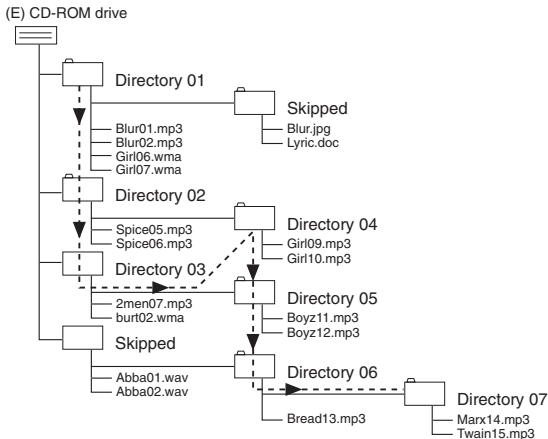

MULTI SESSION

The computer user does not need to finalize the CDR disc as music is burned on the CD. Because of this, the music can be downloaded at different times until the whole CD is full.

NOTES ON THE CHART (PREVIOUS PAGE):

- The arrow pathway shows the sequence of MP3/WMA directory and file playback.
- This example has a total of 7 MP3/WMA directories.
- Based on this layout, the first file will be “Blur01.mp3” and the last file will be “Twain15.mp3”.
- “Skipped” denotes a directory which contains non-audio files only, e.g. jpg, wav, etc. These cannot be detected nor played on this player. When an album contains mixed format files, the non-MP3 or non-WMA files will be skipped.

CARE AND MAINTENANCE

Caring for Compact Discs

- Treat the compact disc carefully. Handle the compact disc only by its edges. Never allow your fingers to come in contact with the shiny, unprinted side of the compact disc.

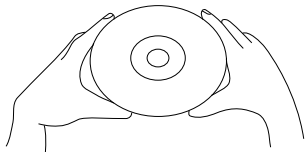

- Do not attach adhesive tape, stickers, etc. to the compact disc label.
- Clean the compact disc periodically with a soft, lint-free, dry cloth. Never use detergents or abrasive cleaners to clean the compact disc. If necessary, use a CD cleaning kit.
- If a compact disc skips or gets stuck on a section of the compact disc, it is probably dirty or damaged (scratched).
- When cleaning the compact disc, wipe in straight lines from the center of the compact disc to the outer edge of the compact disc. Never wipe in circular motions.

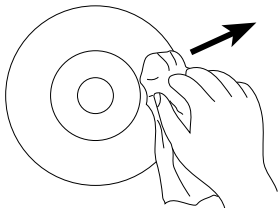

CARE AND MAINTENANCE (CONTINUED)

- Compact discs should be stored in their cases after each use to avoid damage.
- Do not expose compact discs to direct sunlight, high humidity, high temperatures, or dust, etc. Prolonged exposure or extreme temperatures can warp the compact disc.
- Do not stick or write anything on either side of the compact disc. Sharp writing instruments, or the ink may damage the surface.

Cleaning the unit

- To prevent fire or shock hazard, disconnect your unit from the AC power source when cleaning.
- The finish on your unit may be cleaned with a dust cloth and cared for as other furniture. Use caution when cleaning and wiping the plastic parts.
- Mild soap and a damp cloth may be used on the front panel.

TROUBLESHOOTING GUIDE

If you experience a problem with this unit, check the chart below before calling for service.

SYMPTOM	CAUSE	SOLUTION
Unit will not turn on.	Dead batteries, or not installed properly.	Replace batteries, and install properly.
	AC adapter not connected.	Check AC adapter connection.
Disc will not play.	CD compartment not closed.	Close CD compartment.
	Disc inserted incorrectly.	Reinsert disc correctly.
	Dirty or defective disc.	Try another disc.
	Moisture condensation on disc.	Wipe disc with soft cloth.
Erratic CD playback.	Dirty or defective disc.	Clean or replace disc.
No sound from headphones.	Headphone plug not inserted correctly.	Reinsert headphone plug correctly.
	VOLUME control set to minimum.	Increase volume.
	Weak batteries.	Replace batteries.
	Defective disc.	Try another disc.
FM distorted.	Station not tuned.	Retune station and extend headphone wire.

SPECIFICATIONS

Power requirement DC.....	2 x AA (LR6) Alkaline batteries
Power requirement AC.....	DC IN 4.5V Adapter, Center Positive
Disc Diameter.....	4.72" (120mm)
.....	3.15" (80mm) Single CD
Optical Source	Semiconductor Laser
D/A Conversion	1-bit DAC eight times oversampling
MPEG Rate.....	32-384Kbps
Sampling Frequency.....	8/11.025/12KHz for MPEG2.5
.....	16/22.05/24KHz for MPEG2
.....	32/44.1/48KHz for MPEG1
MP3 Playback	ISO9660 format compatible
Output level	Line Output 0.7Vms (47K ohms)
.....	Headphone 14mW (16 ohms)
Frequency Range (FM)	87.5-108MHz

Check the CD burner/recorder's documentation to see if it complies with these specifications.

Specifications are subject to change without notice.

**FOR ADDITIONAL SET-UP OR OPERATING ASSISTANCE,
PLEASE VISIT OUR WEBSITE AT
WWW.MEMOREXELECTRONICS.COM
OR CONTACT CUSTOMER SERVICE AT 1-800-919-3647.**

**PLEASE KEEP ALL PACKAGING MATERIAL FOR AT LEAST 90
DAYS IN CASE YOU NEED TO RETURN THIS PRODUCT TO YOUR
PLACE OF PURCHASE OR TO MEMOREX.**

**FOR PARTS AND ACCESSORIES, CONTACT FOX INTERNATIONAL
AT 1-800-321-6993.**

Memcorp, Inc.
Weston, FL
Printed in Hong Kong

Visit our website at www.memorexelectronics.com